

**Catalog symbols**

Symbol	Fuse type	Description
CCP2-(poles)-30CC	Class CC	Switch only
CCP2-(poles)-30M	UL sup./IEC 10x38	
CCP2-1-DCC	Class CC Vdc	1-pole switch only
CCP2-1-DCM	UL sup./IEC 10x38 Vdc	
CCP2R-(pole)-30CC	Class CC	Right front rotary switch
CCP2R-(pole)-30M	UL sup./IEC 10x38	
CCP2RL-(pole)-30CC	Class CC	Left front rotary switch
CCP2RL-(pole)-30M	UL sup./IEC 10x38	
CCP2S-(pole)-30CC	Class CC	Right side rotary switch
CCP2S-(pole)-30M	UL sup./IEC 10x38	
CCP2SL-(pole)-30CC	Class CC	Left side rotary switch
CCP2SL-(pole)-30M	UL sup./IEC 10x38	

**Description**

The revolutionary next generation Bussmann™ series Compact Circuit Protector (cat. no. CCP2) fused disconnect switch is 3/5 the footprint of a traditional fusible switch and provides up to a high 200 kA Short-Circuit Current Rating (SCCR) to help improve panel and assembly SCCR.

The 35 mm DIN-Rail mount CCP is available in a variety of configurations to meet many application needs including rotary operation.

Application flexibility is extended with an optional multi-wire lug kit, with finger-safe shrouds, that provides three additional wire ports on each pole for power distribution applications.

Other accessories include a PLC interface device for open fuse monitoring and NO/NC auxiliary contacts that easily integrate into many monitoring systems.

Front and side rotary operated versions are easily applied for through-the-door or through the left or right side operation to enhance safety.

**Ratings**

- Volts
  - 600 Vac (UL® Class CC)
  - 240 Vac (UL Supplemental)
  - 400 Vac (IEC 10x38 mm)
  - 80 Vdc (DC Class CC, DC UL Supplemental/IEC)
- Amps
  - 30 A (UL)
  - 32 A (IEC)
- SCCR
  - 200 kA (UL Class CC)
  - 10 kA (UL Supplemental)
  - 120 kA (IEC 10x38 mm max)
  - 20 kA (DC Class CC/UL)
  - 10 kA (DC UL Supplemental/IEC)

**Poles**

- 1-, 2- and 3-poles catalog number dependent

**Agency information**

- UL Class CC fuse versions
  - UL 98 Listed, Guide WHTY, File E302370
  - cULus to Canadian Standard 22.2 No. 4-04, UL Guide WHTY7, File 302370

- UL Supplemental and IEC 10x38 mm fuse versions
  - UL 508 Listed, Guide NRNT, File E320230
  - cULus Certified 22.2 No. 14-05
  - IEC 60947-3 AC-23A
- DC voltage UL Class CC version (CCP2-1-DCC)
  - UL 508 Listed, cULus 22.2, No. 1405
- DC IEC 10x38 version (CCP2-1-DCM)
  - IEC 60947-3, DC-23A
- RoHS compliant
- CE

**Conductors/terminals**

- 75°C Cu/Al, see conductor tables for size, type and torque information
- Box lug, single/dual conductor
- Fork terminal suitable for line, load or accessory connection
- Multi-wire lug kit — see accessories for details

**Storage and operating temperature**

- -20°C to 75°C (-4°F to 167°F)\*

\* For fuse performance under or above 25°C, consult fuse performance derating charts in the Bussmann Division publication no. 3002, titled Selecting Protective Devices (SPD)

**Lockout/tagout provisions**

- Switch only — 4 mm lock or Brady pin-out device part number 90850
- Switch with rotary operating mechanism — 1/4" lock

**Minimum enclosure size**

- 10" x 8" x 6" (254 x 203 x 152 mm)

**Mounting**

- 35 mm DIN-Rail

**Local open fuse indication minimum voltage\*\***

- 90 Vac for AC switches
- 12 Vdc for DC switches

\*\* Open fuse indication requires an open fuse to be in the CCP2 and the switch in the ON position.

**Accessories**

- Multi-wire lug kit with terminal shrouds
- Selector and pistol handles for use with rotary operated switches
- 8 mm shafts for use with selector and pistol handles
- Auxiliary contacts
- PLC fuse monitor

## Features

- Extremely compact (18 mm wide per pole ) design
- High SCCR up to 200 kA (UL Class CC) and 120 kA (IEC)
- Disconnect rated for load isolation
- Full voltage rated up to 600 Vac or 80 Vdc
- UL 98 Listed Class CC version is horsepower rated and suitable for branch circuit protection and disconnect
- IEC 10x38 version complies with IEC 60947-3 and suitable for branch circuit protection and disconnect
- Suitable for global installations, the switches comply with UL, cULus and IEC standards accepting UL Class CC, Supplemental or IEC aM and gG/gL fuses
- Open fuse indication
  - Standard local open fuse indicating light for each pole
  - Optional PLC fuse monitor can be utilized to signal a PLC and open a contactor to de-energize all phases, if required
- IP20 finger-safe with 10 AWG (6 mm<sup>2</sup>) or larger wire (box lug terminals only)
- Built-in switch interlock prohibits removing the fuse under load
- Padlockable handle for lockout/tagout
  - 4 mm lock for switch only
  - 1/4" lock for rotary operated switches
- Rotary operated versions provide for through-the-door and through-the-side operation flexibility and enhanced safety with:
  - Right front switch operation
  - Left front switch operation
  - Right side switch operation
  - Left side switch operation
- Optional selector and pistol handles available for use with rotary operated versions
- Multi-wire lug kit with terminal shrouds allows for power distribution to multiple loads. Each lug has three ports rated for single and dual wires (see lug kit in accessories for conductor and torque details).

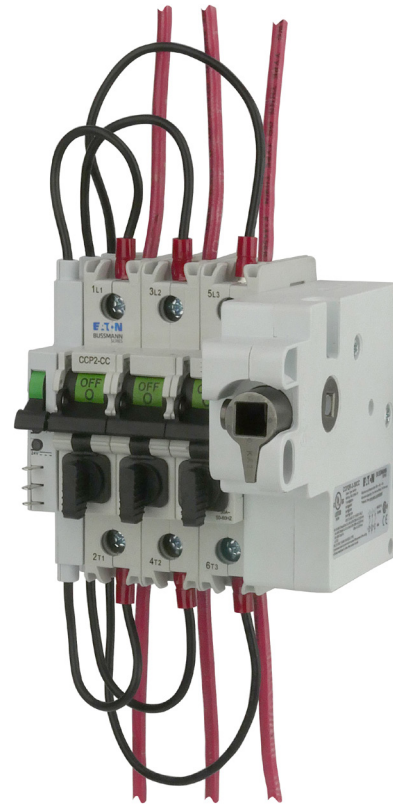

Right front rotary operated CCP2 switch with PLC fuse monitor.

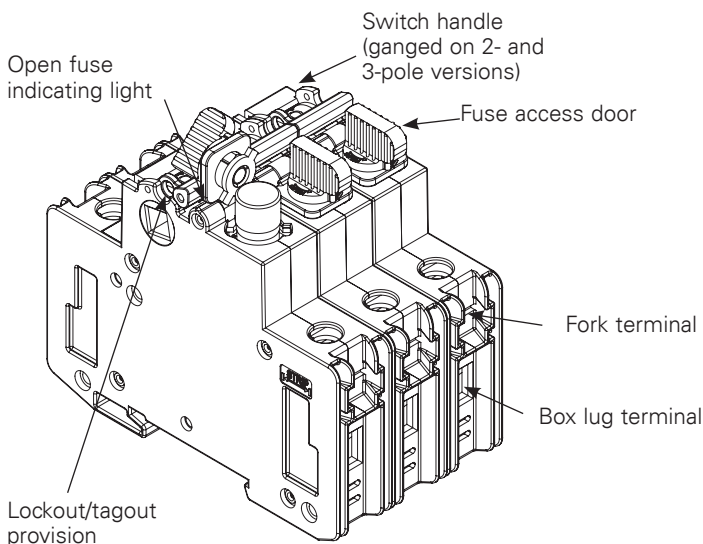

## Rotary operating switch versions

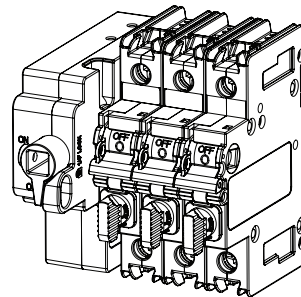

**Left front rotary switch**

Clockwise operating handles

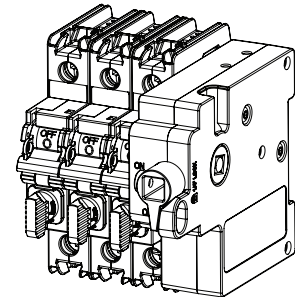

**Right front rotary switch**

Clockwise operating handles

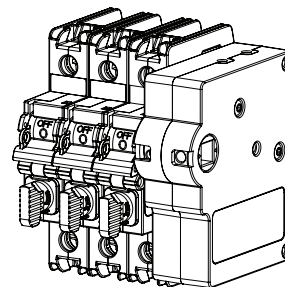

**Right side rotary switch**

Clockwise operating handles

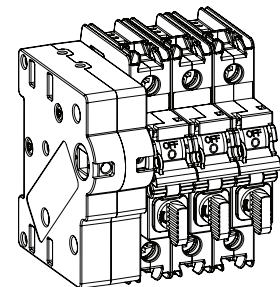

**Left side rotary switch**

Counterclockwise operating handles

**Catalog numbers**

Catalog no.	Poles	Description	Amps	Volts	SCCR	Max horsepower rating (Vac)				Wire type/ size*
						120	240	480	600	
<b>Class CC</b>										
CCP2-1-30CC	1			347 Vac		1/2	—	—	—	
CCP2-2-30CC	2	Switch only		600 Vac		—	2	—	—	
CCP2-3-30CC	3					3/4	3	5	7.5	
CCP2R-2-30CC	2	Switch with right front rotary operation		600 Vac		—	2	—	—	
CCP2R-3-30CC	3					3/4	3	5	7.5	75°C Cu/Al
CCP2RL-2-30CC	2	Switch with left front rotary operation	30 A	600 Vac	200 kA	—	2	—	—	18-4 AWG
CCP2RL-3-30CC	3					3/4	3	5	7.5	Fork terminal††
CCP2S-2-30CC	2	Switch with right side rotary operation		600 Vac		—	2	—	—	
CCP2S-3-30CC	3					3/4	3	5	7.5	
CCP2SL-2-30CC	2	Switch with left side rotary operation		600 Vac		—	2	—	—	
CCP2SL-3-30CC	3					3/4	3	5	7.5	
<b>UL Supplemental and IEC 10x38 mm</b>										
CCP2-1-30M	1									
CCP2-2-30M	2	Switch only								
CCP2-3-30M	3									
CCP2R-2-30M	2	Switch with right front rotary operation								75°C Cu/Al
CCP2R-3-30M	3									18-4 AWG
CCP2RL-2-30M	2	Switch with left front rotary operation	UL 30 A IEC 32 A**	UL 240 Vac† IEC 400 Vac†	UL 10 kA† IEC 120 kA†	—	—	—	—	Fork terminal††
CCP2RL-3-30M	3									
CCP2S-2-30M	2	Switch with right side rotary operation								
CCP2S-3-30M	3									
CCP2SL-2-30M	2	Switch with left side rotary operation								
CCP2SL-3-30M	3									
<b>Single-pole DC switches</b>										
CCP2-1-DCC	1	UL Class CC	30 A	80 Vdc†	20 kA†	—	—	—	—	75°C Cu/Al
CCP2-1-DCM	1	UL supplemental	30 A	80 Vdc†	10 kA†	—	—	—	—	18-4 AWG
		IEC 10x38	32 A**			—	—	—	—	Fork terminal††

\* See box lug terminal conductor data table for details.

\*\*32 A Class aM, 25 A Class gG.

† SCCR may be lower, refer to installed fuse data sheet for interrupting rating at applied voltage.

††Fork terminal with a 4.3 mm gap for a #8-32 stud, 30 A max, insulated flange, wire size 12-10 AWG.

## Box lug terminal conductor data

Type	AWG range	Class	Quantity	Torque N•m (lb-in)
Cu	4-18	Stranded, Class B to K	Single	2.26 (20)
	6-8	Stranded, Class B/C	Dual	3.39 (30)
	6-8	Stranded, Class K	Dual	3.39 (30)
	10-18	Stranded, Class B to K	Dual	2.26 (20)
	10-18	Solid	Single/dual	2.26 (20)
	4-18	Stranded, UL ferrule, Class B/C	Single	3.39 (30)
Al	6-18	Stranded, UL ferrule, Class K	Twin†	2.82 (25)
	4-18	Stranded, UL ferrule, Class K	Single	2.82 (25)
	6-18	Stranded, UL ferrule, Class K	Twin†	2.82 (25)
	4-8	Stranded	Single	2.26 (20)
Al	6	Stranded	Dual	2.82 (25)
	8		Dual	2.26 (20)

† Two stranded conductors placed in one UL Listed twin ferrule.

## Available Bussmann series fuses

Fuse class	Type/description	Volts	Data sheet no.
CC	LP-CC time-delay	600 Vac/300 Vdc*	1023
	FNQ-R time-delay	600 Vac/300 Vdc	1014
	KTK-R fast-acting	600 Vac	1015
M	FNM time-delay	250 Vac	2028
	FNQ time-delay	500 Vac	1012
	KTK fast-acting	600 Vac	1011
	BAF fast-acting	250 Vac	2011
gG/gL	KLM fast-acting	600 Vac/dc	2020
	C10G	500 V (400 V@32 A)	720115
aM	C10M	500 V (400 V@20@25 A)	720115

\* 1/2 to 2-1/2 and 20 to 30 A are 300 Vdc, 2-8/10 to 15 A are 150 Vdc.

## Dimensions – mm (in)

### Switch

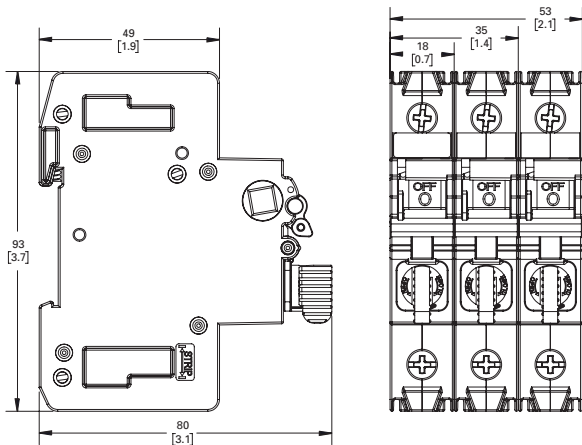

## Left front and right front rotary switches

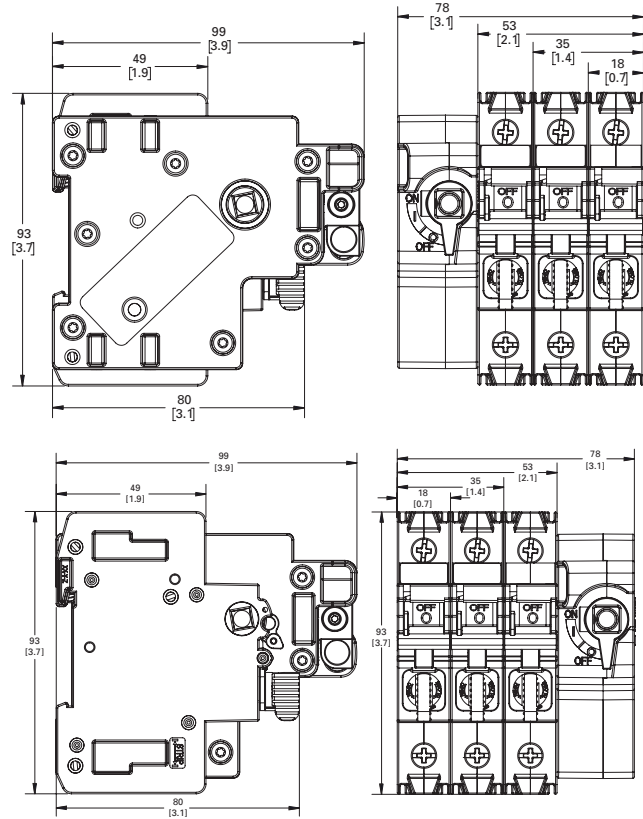

## Left side and right side rotary switches

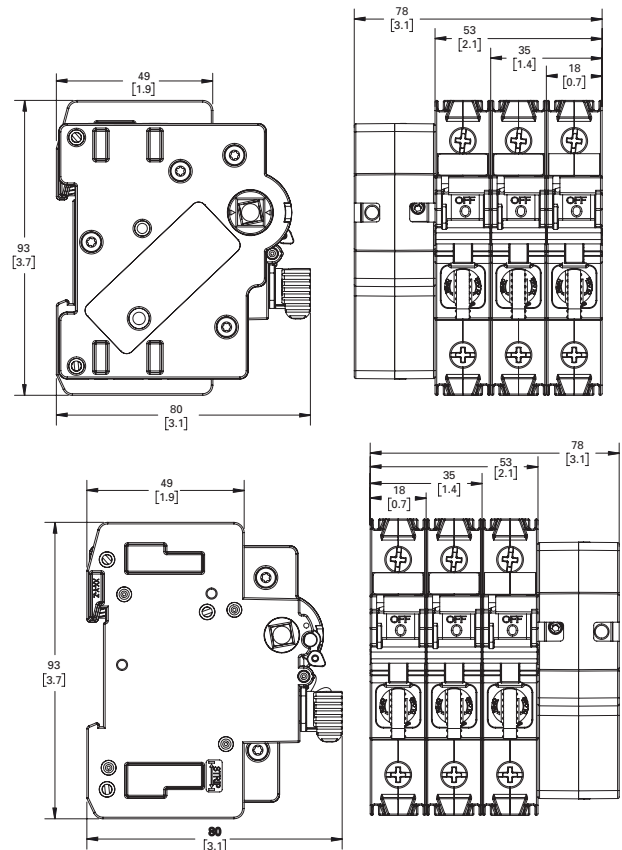

## Multi-wire lug kit

### Catalog number

- CCP2-MW1-3

### Description

The multi-wire lug kit permits expanding each box lug terminal on the switch into a three-port terminal for power distribution applications.

Each multi-wire lug kit comes with three (3) three-port lugs and three terminal shrouds. Shrouds provide finger-safe protection when properly installed.

Lugs may be mounted on either the loadside or lineside to meet various application needs.

Ports on any one lug accept any conductor combination listed, e.g., one of the three ports may have dual 14 AWG wires and the other two ports single 10 AWG wires.

### Ratings

- Volts 600 V
- Amps 60 A max
- SCCR 200 kA

### Agency information

- UL Recognized (lug only)
- RoHS compliant

### Storage and operating temperature

- - 20°C to 75°C (-4°F to 167°F)

### Multi-wire lug conductor information

- 75°C Cu/AL
- AWG size and quantity per port - see table below

Type	AWG range	Class	Quantity	Torque N•m (lb-in)
Cu/Al	4-6	Stranded, Class B/C	Single	3.95 (35)
	8			2.82 (25)
Cu	10-14	Stranded, Class B/C	Single/dual*	2.26 (20)
	10-14			Solid
	8	UL ferrule, Class B to K	Single/twin†	2.82 (25)
	10-14			2.26 (20)

\* Dual wire to be same size and type.

† Two stranded conductors placed in one UL Listed twin ferrule.

### CCP2 box lug torque for multi-wire lug

- 4.52 N•m (40 lb-in)

### Terminal shroud accessory

Terminal shrouds are available without multi-wire terminals.

Catalog no.	Description
CCP2-TS1-3	Pack of three



### Installed on CCP2-3-xx

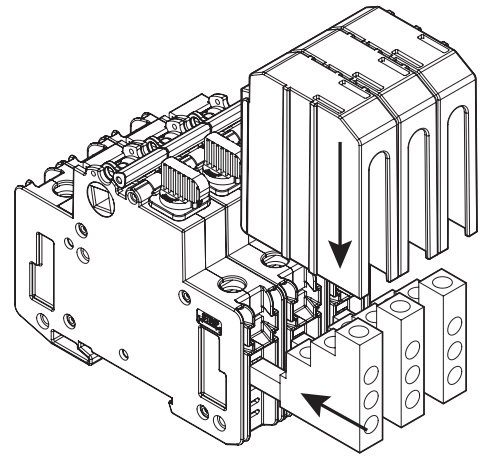

Multi-wire lugs mount in switch box lug terminals to provide three additional wire ports per pole. Lugs can be mounted on the switch lineside or loadside. Each multi-wire lug kit comes with three lugs and three shrouds.

### Wire insulation strip lengths

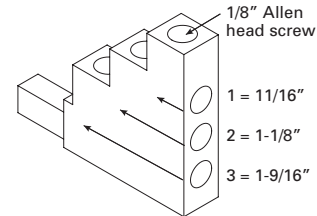

Strip back wire insulation to the lengths as indicated in the illustration above and the table below.

Lug port	Strip wire insulation back (inch)
1	11/16
2	1-1/8
3	1-9/16

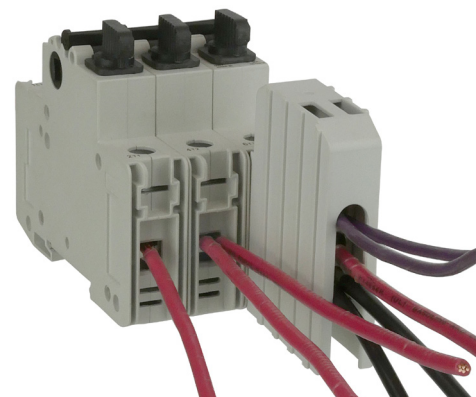

Wiring versatility is provided by single/dual rated box lug terminals on the switch, or by the three-port multi-wire lug kit that's also single/dual wire rated.

## Selector and pistol handles

### Catalog symbol

- CCP2-H4X-

### Description

Selector and pistol handles for use with any 2- and 3-pole CCP2 rotary operated switch. Both selector and pistol handles are available in black/grey and red/yellow colors and clockwise/counterclockwise operating modes. Applying clockwise and counterclockwise operation depends upon the CCP2 rotary switch configuration. Installation requires an 8 mm shaft (ordered separately).

Each handle is rated NEMA 4X and capable of accepting up to three (3) 1/4" diameter shank locks for lockout/tagout in the OFF position. They can also be field configured for lock-on.

In application, only the clockwise operating handles in combination with either the left front or right front rotary switches provide a door interlock means to ensure the enclosure door remains shut during lockout/tagout or lock-on. Both clockwise and counterclockwise operating handles when mounted on the enclosure's left or right side do NOT provide a door interlock means.

See the catalog number table below for applicable rotary switch, handle and shaft combinations.

### Agency information

- UL Listed, Guide DIHS, File E140305
- NEMA 4X rating
- RoHS compliant
- CE

### Storage and operating temperature

- -20°C to 75°C (-4°F to 167°F)

### Packaging

- Each handle is packaged individually

## Handle shafts

### Catalog symbol

- CCP2-SH1-

### Description

Eight millimeter square shafts available in 290 and 490 millimeter (11.5 and 19.3 inch) lengths. Shafts are indexed to ensure handle/switch orientation for correct operation. Shafts are cut to length when installed.

### Packaging

- Each shaft is packaged separately

## Selector handles



## Pistol handles



## Handle shafts



## NFPA 79 compliant handle

### Catalog number

- CCP2-NFPA-1

### Description

NFPA 79 compliant handle mounts on the shaft of front rotary operated switch installations and provide a lockout means independent of the door position.



For these switch catalog numbers	Description/operation	Order these handle catalog numbers (description)	Order either shaft catalog number
CCP2R-(pole)-30CC CCP2R-(pole)-30M	Right front rotary, clockwise	• CCP2-H4X-B1 (selector, black/grey)	
CCP2RL-(pole)-30CC CCP2RL-(pole)-30M	Left front rotary, clockwise	• CCP2-H4X-R1(selector, red/yellow)	
CCP2S-(pole)-30CC CCP2S-(pole)-30M	Right side rotary, clockwise	• CCP2-H4X-B2 (pistol, black/grey)	• CCP2-SH1-290 (11.5"/290 mm)
		• CCP2-H4X-R2 (pistol, red/yellow)	• CCP2-SH1-490 (19.3"/490 mm)
CCP2SL-(pole)-30CC	Left side rotary, counterclockwise	• CCP2-H4X-B1L (selector, black/grey)	
CCP2SL-(pole)-30M		• CCP2-H4X-R1L (selector, red/yellow)	
		• CCP2-H4X-B2L (pistol, black/grey)	
		• CCP2-H4X-R2L (pistol, red/yellow)	

## Auxiliary contacts

### Catalog number

- CCP2-AUX

### Description

NO+NC contact output to indicate the switching mechanism status on the CCP2. A single unit can be mounted on any 1-, 2- or 3-pole CCP2 switch and the left front/left side rotary operated switches.



### Ratings

- Amps up to 5 A
- Volts up to 240 Vac
- NC/NO contacts are closed/open when the CCP2 switch is in the "ON" position (closed)

Description	Max per CCP2*	Signal output
Auxiliary contacts NO+NC for switch status	1 per CCP2 (1-, 2- or 3-pole)	5 A / 240 Vac

\* The CCP2-AUX CANNOT be mounted on the right front and right side rotary operated versions. De-energize all circuits and follow all prevailing safety procedures before installing or removing the CCP2-AUX.

### Agency information

- UL 98 Recognized, Guide WHTY2, File E155130
- cURus to Canadian Standard 22.2 No. 4-04
- IP20 finger-safe in installed state
- RoHS compliant
- CE

### Wiring

- 75°C Cu, 20-16 AWG (0.5 to 1.5 mm<sup>2</sup>) wire
- Torque 0.56 N•m (5 lb-in)

### Packaging

- The CCP2-AUX is packaged individually

### Installation technique

- Mounts on the CCP2's right side ONLY and mechanically interlocks with the CCP2 switch handle with provided hardware. The CCP2-AUX CANNOT be mounted on the right front and right side rotary operated versions.

### Storage and operating temperature

- -20°C to 75°C (-4°F to 167°F)

### Installed on a CCP2-3-xx

**Note:** CCP2-AUX CANNOT be mounted on the right front and right side rotary operated versions.

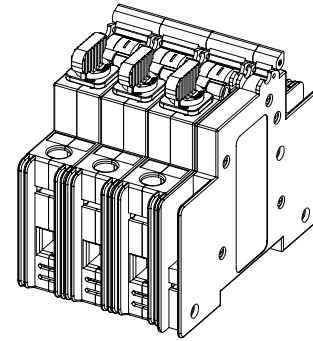

### Dimensions — in

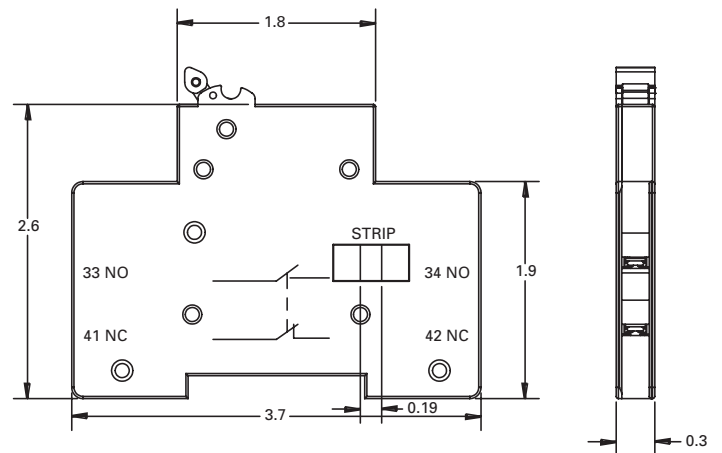

CCP2-AUX auxiliary contacts mounted on a 3-pole CCP2 switch.

## PLC fuse monitor

### Catalog number

- CCP2-PLC-IND

### Description

A resettable three-phase fuse monitor that integrates with the I/O card in a Programmable Logic Controller (PLC). A single unit can be mounted on any 1-, 2- or 3-pole CCP2 switch and the right front/ right side rotary operated switches. A single unit monitors up to three phases. When used on 1- and 2-pole switches unused conductor(s) are removed after installation.

The CCP2-PLC-IND **CANNOT** be mounted on the left front/left side rotary operated versions or if the multi-wire lug kit is installed.

### Ratings

- Signal output to PLC\*
  - +24 Vdc, 10 mA max
- Output signals
  - Digital 0 Vdc (low), 24 Vdc max (high)
  - 0 Vdc Low – fuse is good
  - 24 Vdc High – fuse has opened

\* When the fuse opens, the output signal is sent high and will remain high until the unit is reset.

### Emissions and immunity testing

- IEC 60947-1: Voltage Switchgear and Control Gear
- IEC 61000-6-2: Electromagnetic Compatibility (EMC)
  - IEC 61000-4-2: Electrostatic Discharge Immunity - Test at level 3 (6 kV-Contact Discharge) and level 2 (4 kV-Air Discharge)
  - IEC 61000-4-3: Electromagnetic Compatibility - Radiated, Radio-frequency, Electromagnetic Field Immunity test at level x (20 V/m)
  - IEC 61000-4-4: Electromagnetic Compatibility - Testing and Measurement Techniques at level 3 ( $\pm 2$  kV - Power Port and  $\pm 1$  kV - I/O Ports)
  - IEC 61000-4-5: Electromagnetic Compatibility - Surge Immunity test at level 4 ( $\pm 4$  kV)
  - IEC 61000-4-6: Immunity to Conducted Disturbances at level 3 (10 V)

Description	Max per CCP2**	Signal output to PLC	Min. circuit volts
Wired remote fuse indication for PLC applications	1 per CCP2 (1, 2- or 3-pole)	24 Vdc/ 10 mA	100 Vac

\*\*The CCP2-PLC-IND CANNOT be mounted on the left front/left side rotary operated versions or if the multi-wire lug kit is installed.

De-energize all circuits and follow all prescribed safety procedures before installing or removing the CCP2-PLC-IND.

### Agency information

- UL 98 Recognized, Guide WHTY2, File E155130
- cURus to Canadian, Standard 22.2 No. 4-04

### Local indication

- Two distinct LEDs indicate unit power (green) and open fuse (red). Open fuse LED is resettable upon fuse replacement and actuating the reset switch.

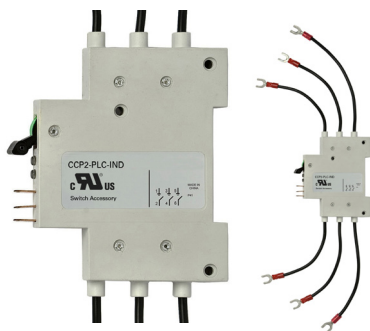

### Wiring

- For power, signal and ground connections use shielded twisted pair 22-24 AWG (0.34-0.25 mm<sup>2</sup>) 300 V rated wire

### Packaging

- The CCP2-PLC-IND is packaged individually
- Includes 0.110" (2.8 mm) quick connects for power, signal and ground connections

### Installation technique

- Mounts on the left side ONLY of the CCP2 and mechanically interlocks with the CCP2 switch handle with hardware provided. The CCP2-PLC-IND **CANNOT** be mounted on the left front/ left side rotary operated versions or if the multi-wire lug kit is installed.

### IP20 rating — yes

### Storage and operating temperature

- -20°C to 75°C (-4°F to 167°F)

### PLC programming

- The CCP2-PLC-IND signal line is designed to provide a digital input to a PLC I/O card. In this case, a Programmable Logic Control program must be written to properly interpret the input signal to the PLC. The PLC program should check for consecutive high signals before taking action on a critical process.

### Installed on a CCP2-3-xx

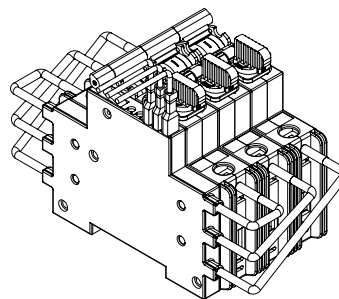

CCP2-PLC-IND mounted on a 3-pole switch and using the fork terminals. When mounted on a 2- or 1-pole switch, remove unused leads.

**Note:** The CCP2-PLC-IND **CANNOT** be mounted on the left front/left side rotary operated versions or if the multi-wire lug kit is installed.



CCP2-PLC-IND fuse monitor mounted on a right front rotary operated switch.

**PLC wiring schematic**

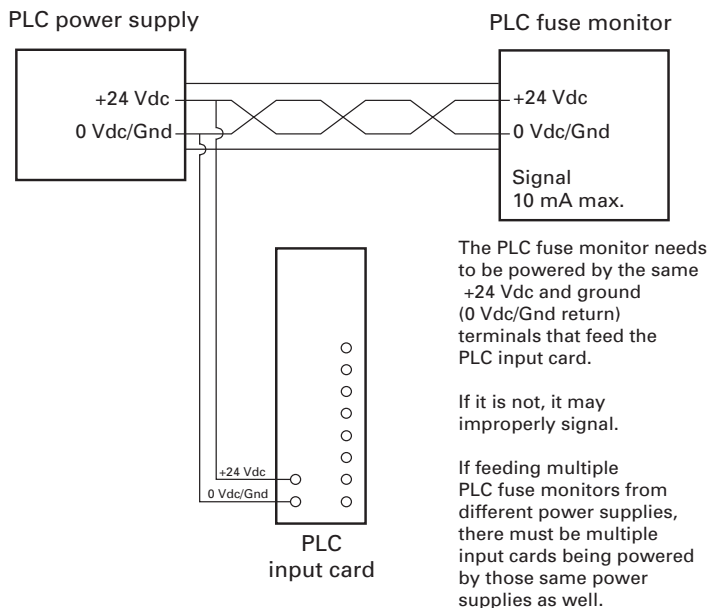

**CCP2-PLC-IND connections from a CCP2-3-xx to a remote monitoring device**

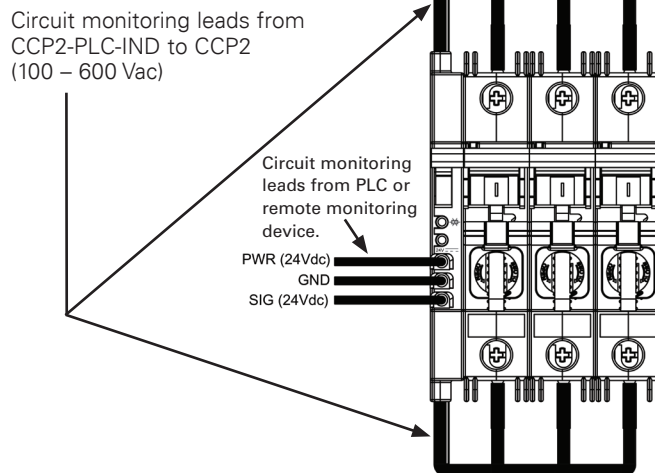

Disconnect switches

**Connection from CCP2-PLC-IND to CCP2-3-xx**

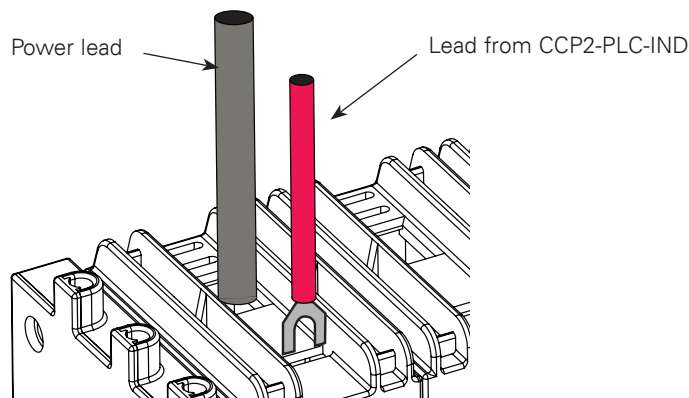

Leads from CCP2-PLC-IND are connected to the fork terminals as shown.





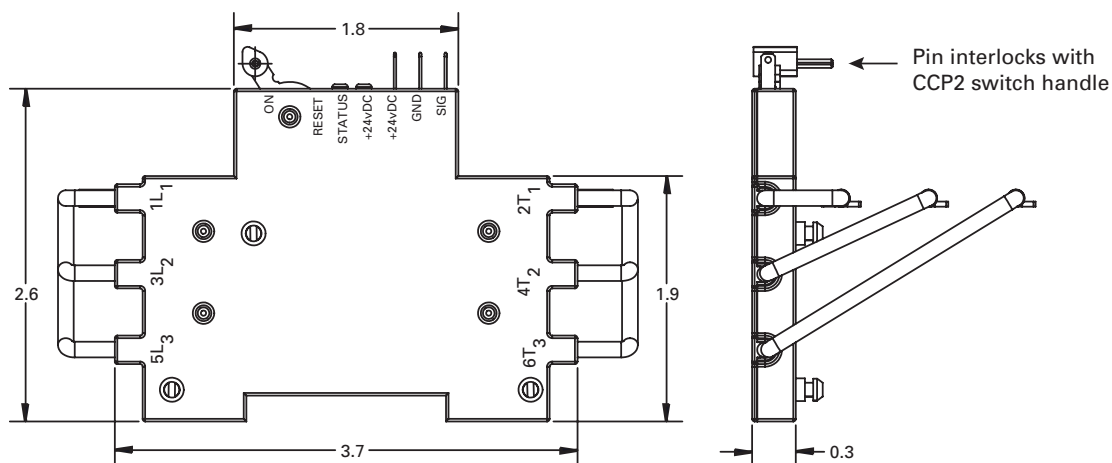

**Note:** When monitoring a 1- or 2-pole switch, remove unused leads.



**Dimensions — in**



## Class CC and UL Supplemental (IEC 10x38) clockwise rotary switches

For a complete assembly, select from the following required and optional components, and accessories.



<b>Required</b>	<b>Catalog no.</b>			
	<b>Switches</b>	<b>Amps</b>	<b>Poles</b>	
	<b>Right front rotary</b>			
		CCP2R-2-30CC	30	2
		CCP2R-3-30CC		3
		CCP2R-2-30M		2
		CCP2R-3-30M		3
	<b>Left front rotary</b>			
		CCP2RL-2-30CC	30	2
		CCP2RL-3-30CC		3
		CCP2RL-2-30M		2
		CCP2RL-3-30M		3
	<b>Right side rotary</b>			
		CCP2S-2-30CC	30	2
		CCP2S-3-30CC		3
CCP2S-2-30M		2		
CCP2S-3-30M		3		
<b>And</b>				
	<b>Rotary handles</b>	<b>Description</b>	<b>NEMA rating</b>	
	CCP2-H4X-B1	Selector handle — black/grey	4X	
	CCP2-H4X-R1	Selector handle — red/yellow		
	CCP2-H4X-B2	Pistol handle — black/grey		
	CCP2-H4X-R2	Pistol handle — red/yellow		
<b>And</b>				
	<b>Shafts (8 mm)</b>	<b>Length</b>		
	CCP2-SH1-290	290 mm		
	CCP2-SH1-490	490 mm		
	<b>NFPA 79 compliant handle</b>	<b>Color</b>		
	CCP2-NFPA-1	Red		
<b>And</b>				
<b>Optional</b>	<b>Lug kits</b>	<b>Description</b>		
		CCP2-MW1-3	3-port multi-wire, 75°C Cu/Al, 6-14, includes terminal shrouds, pack of 3	

And			
Accessories		<b>Terminal shrouds</b>	<b>Description</b>
		CCP2-TS1-3	Pack of 3
		<b>Auxiliary contacts</b>	<b>Description — cannot be used on right front or right side operated switches</b>
	CCP2-AUX	NO + NC, 5 A / 240 V	
	<b>PLC fuse monitor</b>	<b>Description — Cannot be used on left front operated switches</b>	
	CCP2-PLC-IND	Signal output 24 Vdc / 10 mA	

Disconnect switches

## Class CC and UL Supplemental (IEC 10x38) Switches

For a complete assembly, select from the following required and optional components, and accessories.

Required	Catalog no.		
	Switches	Amps	Poles
	Switch		
		CCP2-1-30CC	30
CCP2-2-30CC		2	
CCP2-3-30CC		3	
CCP2-1-30M		1	
CCP2-2-30M		2	
CCP2-3-30M		3	
And			
Optional	Lug kits	Description	
		CCP2-MW1-3	3-port multi-wire, 75°C Cu/Al, 6-14, includes terminal shrouds, pack of 3
And			
Accessories	Terminal shrouds	Description	
		CCP2-TS1-3	Pack of 3
	Auxiliary contacts	Description	
		CCP2-AUX	NO + NC, 5 A / 240 V
PLC fuse monitor	Description		
	CCP2-PLC-IND	Signal output 24 Vdc / 10 mA	

**Class CC and UL Supplemental (IEC 10x38) counterclockwise switches**

For a complete assembly, select from the following required and optional components, and accessories.

<b>Required</b>	<b>Catalog no.</b>			
	<b>Switches</b>	<b>Amps</b>	<b>Poles</b>	
	<b>Left side rotary</b>			
		CCP2SL-2-30CC	30	2
		CCP2SL-3-30CC		3
		CCP2SL-2-30M		2
		CCP2SL-2-30M		2
	<b>And</b>			
		<b>Rotary handles</b>	<b>Description</b>	<b>NEMA rating</b>
		CCP2-H4X-B1L	Selector handle — black/grey	4X
CCP2-H4X-R1L		Selector handle — red/yellow		
CCP2-H4X-B2L		Pistol handle — black/grey		
CCP2-H4X-R2L		Pistol handle — red/yellow		
<b>And</b>				
	<b>Shafts (8 mm)</b>	<b>Length</b>		
	CCP2-SH1-290	290 mm		
	CCP2-SH1-490	490 mm		
<b>And</b>				
<b>Optional</b>		<b>Lug kits</b>	<b>Description</b>	
		CCP2-MW1-3	3-port multi-wire, 75°C Cu/Al, 6-14, includes terminal shrouds, pack of 3	
<b>And</b>				
<b>Accessories</b>		<b>Terminal shrouds</b>	<b>Description</b>	
		CCP2-TS1-3	Pack of 3	
		<b>Auxiliary contacts</b>	<b>Description —mounts on right side</b>	
CCP2-AUX		NO + NC, 5 A / 240 V		

Disconnect switches